



ENTRY DOOR SINGLE CYLINDER DEADBOLT INSTALLATION INSTRUCTIONS

BEFORE YOU BEGIN

Check the thickness of the door. The product will work with a door thickness of 1-3/8" - 1-3/4" only.









Note

- If your door is pre-bored, go to Step 1 for deadbolt installation. If your door is not pre-bored, go to Step 2 and 3 for preparing the door for strike.
- The deadbolt for this handleset has an adjustable backset. The deadbolts are preset to a 2-3/8" backset. Only adjust the deadbolts if your door is prebored to a 2-3/4" backset.

TOOLS REQUIRED:

- Phillips screwdriver or power screwdriver 

ADDITIONAL TOOLS IF DOOR IS NOT PRE-BORED:

- Center punch 
- 1/8" drill bit 
- 3/8" drill bit 
- 7/8" spade bit 
- Wood chisel 
- 2-1/8" hole saw 
- 1" spade bit 
- Drill 

INSTALLATION FASTENERS

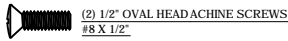

(2) 1/2" OVAL HEAD MACHINE SCREWS
#8 X 1/2"

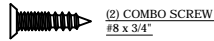

(2) COMBO SCREW
#8 X 3/4"



(2) DEADBOLT MOUNTING SCREW
#10-32 X 2"



(2) 1-1/4" WOOD SCREW
#10 X 1-1/4"

EXPLODED VIEW

PART IDENTIFICATION

1. Adjustable deadbolt
2. Combo screws
3. Flat head wood screws
4. Strike
5. Key
6. Key cylinder
7. Cylinder collar
8. Turnpiece mounting plate
9. 2" Pan head machine screws
10. Turnpiece trim
11. 1/2" Oval head machine screws

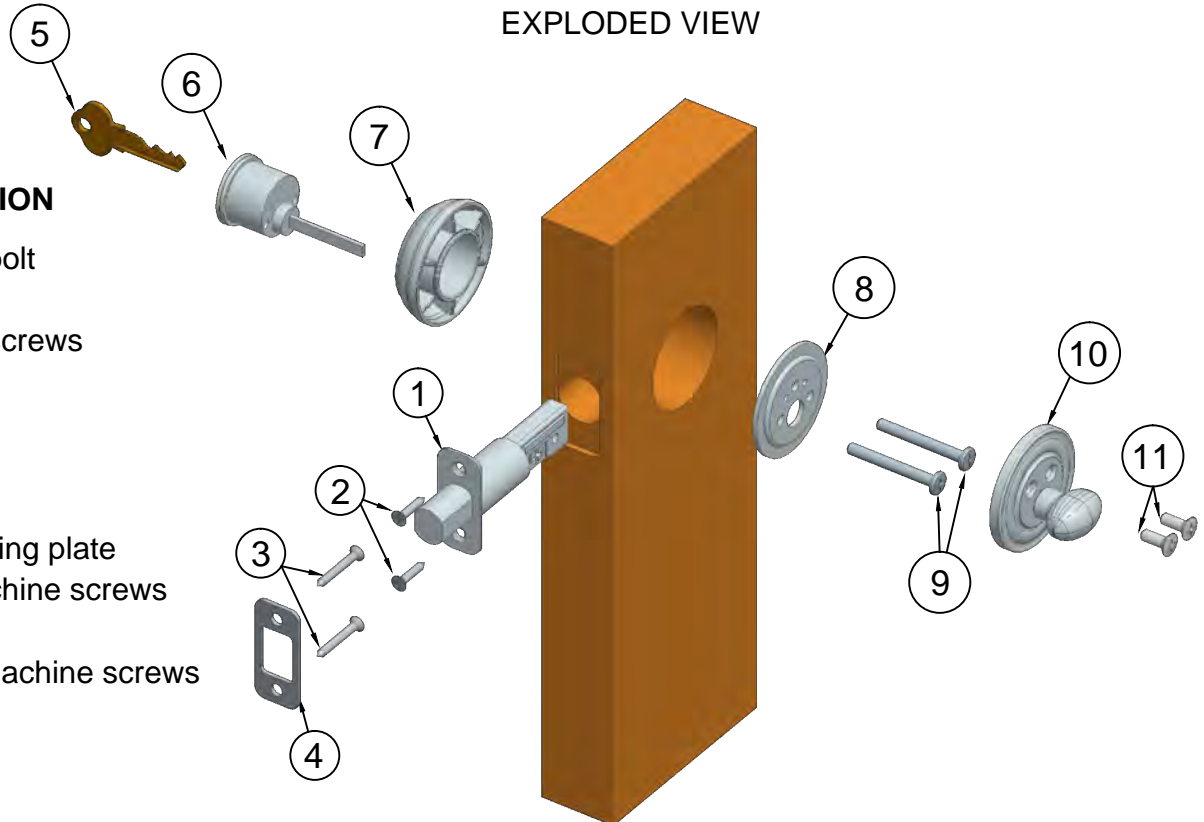

1 HANDLE INSTALLATION

- A. Install the deadbolt into the door panel.** Insert the deadbolt into the top bore ensuring the "+" slot is underneath and ridge on top. Using a 1/8" drill bit drill two pilot holes and secure the deadbolt with two flat head wood screws. Ensure the bolt is extended for installation.
Note: To extend the head of the deadbolt, insert a screwdriver into the "+" slot and rotate.
- B. Install the key cylinder.** Keeping the tailpiece vertical, insert the key cylinder through cylinder collar and into the "+" slot of the deadbolt. Secure the exterior cylinder by driving two 2" pan head machine screws through the mounting plate, deadbolt and into the exterior cylinder.
DO NOT OVER TIGHTEN SCREWS AND DO NOT INSERT KEY INTO KEY CYLINDER DURING THIS STEP.
- C. Install the turnpiece trim.** Position the turnpiece trim over the mounting plate, inserting the key cylinder tailpiece into the turnpiece. Secure in place by driving two 1/2" oval head machine screws through the two chamfered holes.

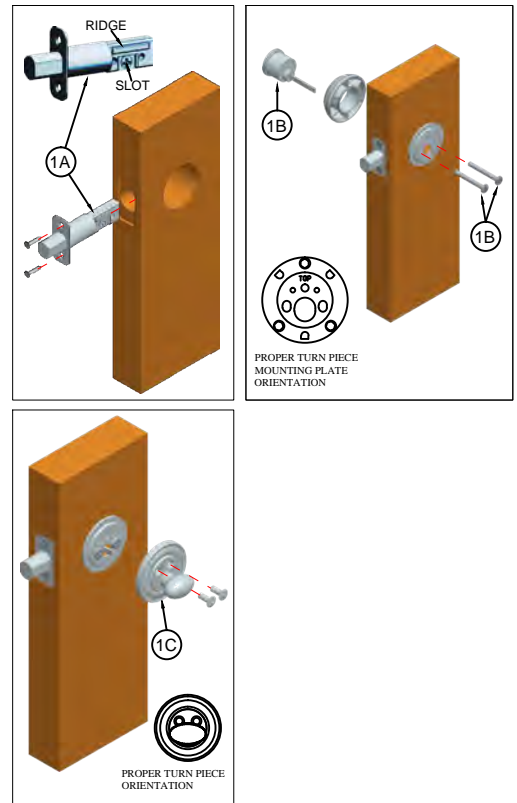

2 PREPARING DOOR FOR DEADBOLT

Note: The following instructions are for doors that have not been pre-bored ONLY.

A. Fold the template on the line and place on the door at the desired height (approximately 40" from the floor). Use a center punch to mark the hole locations on the face and edge of the door panel.

Caution: RE-CHECK bore hole locations BEFORE drilling.

B. Drill the face bores and edge bores as indicated on the template.

C. Insert the latch into the edge of the door. Trace an outline of the faceplate onto the door's edge and mark the screw hole centers.

D. At the screw hole marks, drill two 1/8" diameter pilot holes for the screws.

E. Chisel out the area marked in Step C to a depth of 5/32" or until the faceplate is flush with the door's edge.

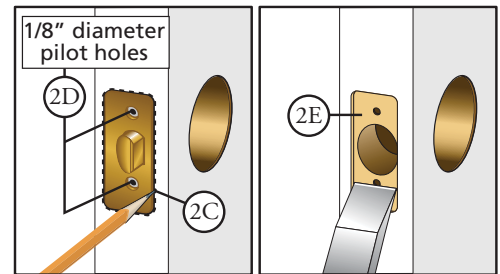
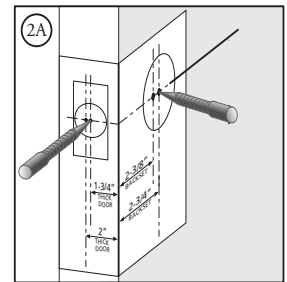

3 PREPARING DOOR FOR STRIKE INSTALLATION

A. Using the strike portion of the marking template locate and use a center punch to mark the strike mounting screws and centering points for the door thickness.

B. Align the strike and trace the outline onto the door frame using the mounting screw marks for location.

C. At the screw marks, drill two 1/8" diameter pilot holes for the screws.

D. At the centering point mark, bore a 7/8" diameter by 3/4" deep hole.

E. Chisel the areas mark in Step B until the strike is flush with the door frame.

F. Place the strike and secure with the two screws provided.

